

# 4117CTK PRO-FIT® 4 - 1.28



Complete Toilet Kit, Round Front, SmartHeight™, Vitreous China, Two-Piece Toilet

## FEATURES

- Complete toilet kit (CTK)
- 3-bolt SmartFaster™ tank-to-bowl connection
- 1.28 gpf / 4.8 lpf high efficiency water consumption
- Uses 20% less water than conventional toilets
- Round front SmartHeight™ bowl
- 3-2" hybrid flapper flush valve
- Fluidmaster® anti-siphon pilot fill valve
- 12" rough-in
- Model 31 color-match, plastic trip lever
- 2" glazed trapway
- Mansfield® limited lifetime warranty
- Available in White



**MODEL 4117CTK**

Toilet seat included

Complete toilet kit



ROUND





SMARTHEIGHT ADA



CTK

## COMPONENTS

MODEL #	DESCRIPTION	CODES/STANDARDS
4117CTK	Round front, SmartHeight™, two-piece toilet kit. Includes: toilet seat, wax toilet ring, floor bolts, caps, and multi-lingual installation instructions. Water supply hardware not included.	  
117	Round front, SmartHeight™ toilet bowl only. Less toilet seat.	
3173	Tank and cover only with left hand, front-mount, color-match, plastic trip lever. Fluidmaster® anti-siphon pilot fill valve. Less supply.	
SB100	Round, closed front, plastic toilet seat and cover.	
TANK TRIM & REPLACEMENT PARTS		
31	Trip lever - color-match plastic trip lever, left hand	
228	3-2" Hybrid flapper flush valve	
400A	Fluidmaster® anti-siphon pilot fill valve	
2206	Anti-siphon pilot fill valve (compatible replacement)	
630-0207	3" Replacement flapper kit	
160-LID	Tank lid	

When properly installed, this product meets the requirements for the Americans with Disabilities Act of 1990 (ADA). Refer to local plumbing codes, as they may vary by location and application.





# 4117CTK PRO-FIT® 4 - 1.28



Complete Toilet Kit, Round Front, SmartHeight™, Vitreous China, Two-Piece Toilet

## SPECIFICATIONS

MODEL #	DESCRIPTION	CODES/STANDARDS
4117CTK	Round front SmartHeight™ (1.28 gpf / 4.8 lpf) two-piece, complete toilet kit.	  

MATERIAL	Vitreous China
WATER PRESSURE RANGE	20 to 80 PSI
FLUSH SYSTEM	3-2" Hybrid flapper flush valve
WATER USAGE	1.28 gpf / 4.8 lpf
WATER SURFACE AREA	8' X 9'
ROUGH-IN	12'
MAP RATING	800 grams

TRAP DIAMETER	2'
TRAP SEAL	2-7/8"
SHIPPING WEIGHT	Model 4117CTK - 85 lbs. (38.5 kg)
WARRANTY	Vitreous China - Limited Lifetime Tank Trim - Limited One Year

## TECHNICAL INFORMATION

**Note:** these dimensions are nominal and subject to change without notice.

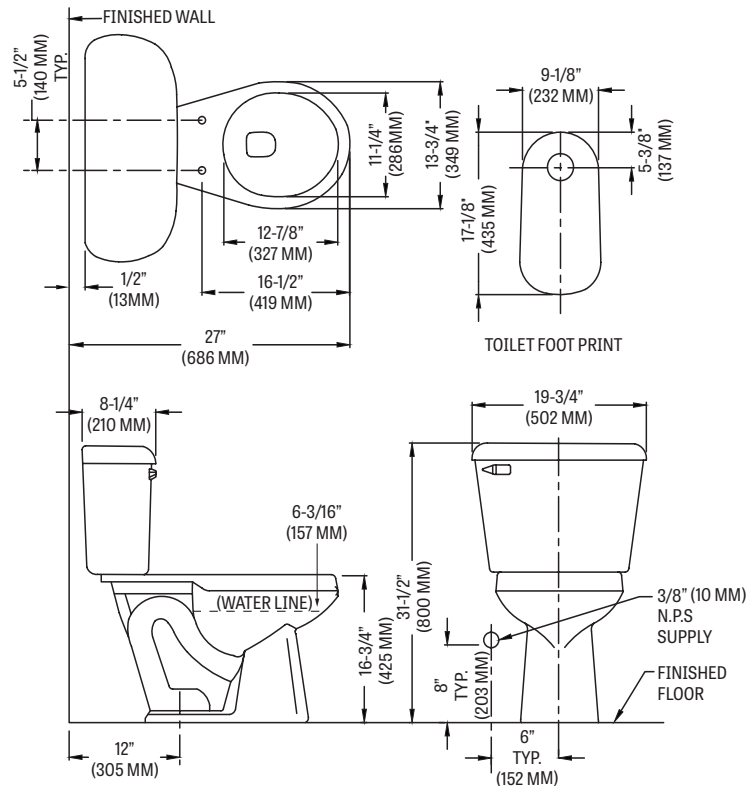

Fixture performance and specifications meet or exceed ASME A112.19.2/CSA B45.1 standards, and other state and local codes.

